



Assessing heritage significance



NSW
Heritage
Office

Acknowledgments

Much of the information contained in the NSW Heritage Manual has been adapted from, and replaces, the State Heritage Inventory Project, including reports prepared by consultants to the former Heritage Branch, NSW Department of Planning. The principal source documents are:

Colleran, Jocelyn (Feb-Mar 1990), State Heritage Inventory Manual: Policy and Procedures. JRC Planning Services.

Domicelj, Joan (Dec 1989), State Heritage Inventory: Status and Scope. Final Report, vols 1 and 2.

Domicelj, Joan (Mar 1993), A Review and Extension of Criteria for the State Heritage Inventory.

Jeans, Prof. Dennis & Jack, Prof. Ian (Jun 1990), State Historical Guidelines, University of Sydney. This has been published under the title Regional Histories by the NSW Heritage Office and the Department of Urban Affairs and Planning in 1996.

Mackay, Richard & Haertsch, Sue (1994), State Heritage Inventory Project: Draft Historical Themes and Evaluation Criteria. Godden Mackay Pty Ltd.

Heritage Office and Department of Urban Affairs and Planning (1996), Heritage Assessments, NSW Heritage Manual, HO/DUAP, Sydney.

The work of **Sheridan Burke, Dr Carol Liston, Penelope Pike, Meredith Walker**, the History Panel of the Heritage Council and the many comments received from interested local council members and staff, practitioners and the community are also gratefully acknowledged.

DISCLAIMER

Any representation, statement, opinion or advice, expressed or implied in this publication is made in good faith but on the basis that the State of New South Wales, its agents and employees are not liable (whether by reason of negligence, lack of care or otherwise) to any person for any damage or loss whatsoever which has occurred or may occur in relation to that person taking or not taking (as the case may be) action in respect of any representation, statement, or advice referred to above.

© Crown copyright 2001

Printed July 2001

ISBN 1 876415 53 3

HO 01/05

Assessing heritage significance



Contents

1	The NSW heritage management system	2
	Why assess heritage significance?	4
	Statements of heritage significance	4
	When to assess significance	4
	Skills required	5
	The role of the local community	5
	The role of history	5
2	The NSW heritage assessment procedure	6
3	Heritage significance criteria	8
4	NSW heritage assessment criteria	9
5	How to assess heritage significance	10
6	Gradings of significance	11
7	Using the heritage significance criteria	12
8	Other information	28
	Using a standard procedure	28
	Aboriginal heritage assessment	28
	Archaeological heritage assessment	28
	Natural heritage assessment	28
	Statutory heritage lists	29
	The State Heritage Register	29
	The State Heritage Inventory	29
	Other heritage lists	29

1.

The NSW heritage management system

The NSW Government is responsible for the management of our cultural and natural heritage in partnership with local councils and the community. The NSW heritage management system consists of three steps in managing individual heritage items:

- **investigate significance**
- **assess significance**
- **manage significance**

The *NSW Heritage Manual* explains these steps, which apply to all kinds of heritage items, from individual houses and

movable items to archaeological and industrial sites, conservation areas, landscapes and natural areas. They also apply to items of any level of significance, from local heritage significance to world heritage significance. In practical terms, however, the vast majority of items managed in New South Wales will be of local significance. A smaller number will be of State significance.

The chart below summarises the processes in the NSW heritage management system.

Step 1 > INVESTIGATE significance

- Investigate the historical context of the item or study area
- Investigate the community's understanding of the item
- Establish local historical themes and relate them to the State themes
- Investigate the history of the item
- Investigate the fabric of the item

Step 2 > ASSESS significance

- Summarise what you know about the item
- Describe the previous and current uses of the item, its associations with individuals or groups and its meaning for those people
- Assess significance using the NSW heritage assessment criteria
- Check whether you can make a sound analysis of the item's heritage significance
- Determine the item's level of significance
- Prepare a succinct statement of heritage significance
- Get feedback
- Write up all your information

[This guideline explains Step 2.]

Step 3 > MANAGE significance

- Analyse the management implications of the item's level of significance
- Analyse the constraints and opportunities arising out of the item's significance (including appropriate uses)
- Analyse owner and user requirements
- Prepare conservation and management recommendations
- If any obvious options are not suitable, explain why
- Get feedback from the community
- Analyse statutory controls and their relationship to the item's significance
- Recommend a process for carrying out the conservation and management strategies



This guideline explains the second step in this process – **ASSESS significance**. It is an update to the Heritage Assessments guideline published in the *NSW Heritage Manual* in 1996. The Manual is a comprehensive set of guidelines explaining the NSW heritage management system.

The other components of the Manual are:

- History and Heritage*
- Investigating History*
- Investigating Fabric*
- Altering Heritage Assets*
- Planning and Heritage*
- Heritage Planning Practice Notes 1 & 2*
- Statements of Heritage Impact*
- Heritage Approvals*
- Heritage Studies*
- NSW Government & Heritage*
- Conservation Management Documents*
- Heritage Nominations*

FURTHER INFORMATION:

- Heritage Terms and Abbreviations*
- Heritage Contacts*
- Heritage References*

COMPANION DOCUMENTS:

- Archaeological Assessments*
- Conservation Areas*
- Heritage Curtilages*
- Regional Histories*

1. The NSW heritage management system (cont.)

Why assess heritage significance?

Before making decisions about the future of a heritage item it is first necessary to understand its heritage values. This leads to decisions that will retain these values in the future.

Statements of heritage significance

The main aim in assessing significance is to produce a succinct statement of significance, which summarises an item's heritage values. The statement is the basis for policies and management structures that will affect the item's future. It is important to get it right. In most cases a short paragraph will suffice. An item of particular importance to the heritage of the State may require a statement that takes up a page or more.



When to assess significance

The assessment of significance, and the statement that it produces, is the basis for all good heritage decisions. It's a process that should be used as part of the management of all heritage items because it clarifies why the item is important.

There is a range of situations when assessment is needed. These include:

1. making decisions about whether to retain an item;
2. considering changes to an item;
3. preparing a heritage study (see the *Heritage Studies* guide in the *NSW Heritage Manual*);
4. preparing a conservation management plan (see the *Conservation Management Documents* guide in the *NSW Heritage Manual*);
5. considering an item for listing on the State Heritage Register or on the schedule of heritage items in a local environmental plan; or
6. preparing a statement of environmental effects or a heritage or environmental impact statement as part of the development and building approval process (see the *Heritage Approvals* and *Statements of Heritage Impact* guides in the *NSW Heritage Manual*).

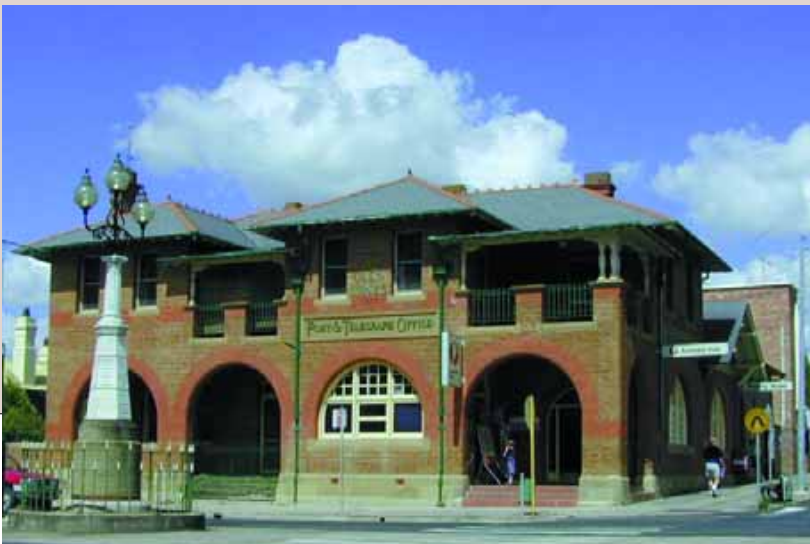

Skills required

Heritage assessments can be carried out by anybody who understands the NSW heritage management process and who has training and experience in the area. As well as gathering information and relating it to the item, an assessor needs to evaluate its comparative significance. What counts is personal knowledge and experience in assessing the significance of heritage items and places.

Professional heritage consultants, staff from the Heritage Office and council officers or heritage advisers based at your local council can offer valuable assistance. It is usually advisable to seek a professional opinion before an assessment is submitted to a local or State government authority.

The role of the local community

The aim of the NSW heritage management system is to conserve important places and objects from the past so they can be appreciated and enjoyed by future generations. The knowledge and values of the community are therefore important ingredients in the assessment process.

Historical societies, local libraries and museums and larger organisations such as the Institution of Engineers, Royal Australian Historical Society, Royal Australian Institute of Architects and the National Trust of Australia (NSW) can all provide valuable information for heritage assessments. Relatives and friends of owners and the wider community may be able to provide documents and photographs and informed judgments, all of which can be useful in making comparative analyses.

Community consultation requires a clear focus and a sensitivity to differing and sometimes conflicting values. It is preferable that there is broad community support for heritage assessments. This will make future management more effective.

The role of history

The relationship between an item and its historical context underlies the assessment process. Historical themes provide a context within which the heritage assessment criteria are applied, especially if historical values are critical to an understanding of an item's heritage significance.

Local historical themes are usually identified by qualified historians with reference to an historical context report prepared as part of a heritage study. State historical themes have been developed by the Heritage Council of NSW to connect local issues to the broader history of NSW (see *History and Heritage* in the *NSW Heritage Manual*).

Historical themes help in evaluating comparative significance, as like items under like themes can be compared and their rarity or representativeness assessed. Applying the themes also helps to prevent one value from taking precedence over others. Themes such as *events*, *industry*, *social institutions* or *welfare* help in deciding whether historical or social values may be more important to the heritage significance of a building than its aesthetics or research potential.



2.

The NSW heritage assessment procedure

Before undertaking a heritage assessment it is essential to have a full understanding of the item based on documentary and oral research and the physical investigation of its fabric. The *NSW Heritage Manual* guidelines *Investigating History* and *Investigating Fabric* cover these steps.

The steps in assessing heritage significance are:

- **Summarise what you know about the item**
- **Describe the previous and current uses of the item, its associations with individuals or groups and its meaning for those people**
- **Assess significance using the NSW heritage assessment criteria**
- **Check whether you can make a sound analysis of the item's heritage significance**
- **Determine the item's level of significance**
- **Prepare a succinct statement of heritage significance**
- **Get feedback**
- **Write up all your information**

Step 1 >

Summarise what you know about the item

Essential information includes:

- first-hand knowledge of the item and its fabric;
- physical description of the item and its curtilage (setting);
- its historical context;
- historical themes relevant to the item;
- plans, photos and other documents.

Step 2 >

Describe the previous and current uses of the item, its associations with individuals or groups and its meaning for those people

This step involves going beyond the usual sources and often entails primary research to obtain information on:

- archaeological potential;
- community values relating to the item;
- oral histories of the people associated with the item;
- documentation and analysis of the fabric of the item.

Step 3 >

Assess significance using the NSW heritage assessment criteria

Refer to all criteria.

An item must meet at least one criterion. Some items will meet more than one.

Step 4 >

Check whether you can make a sound analysis of the item's heritage significance

Loss of the integrity or condition of an item may diminish its significance.

Has it been altered so much that it fails to meet the relevant assessment criterion?

Refer to the context as of the item (a movable item removed from its important context may have lost much of its significance).

Note the condition of the item (but be careful not to let its condition determine its significance).

Use the historical themes and the inclusion and exclusion guidelines in the following section of this guideline.



Step 5 >

Determine the item's level of significance

State significance means significance to the people of NSW.

Local significance means significance within the local government area.

Some items of local significance may have values that extend beyond the local government area, or need a wider contextual consideration. Where this is the case these values should be included in the statement of heritage significance.

Step 6 >

Prepare a succinct statement of heritage significance

The statement should answer the question: "Why is this item important?"

It should indicate the specific heritage values of the item.

It should summarise, but not simply reiterate, the analysis in Step 3.

If an item is historically significant because it demonstrates a significant activity the statement must describe the activity and why it is important.

If an item is a rare example of a particular architectural style in an area, identify the area to qualify the item's rarity. A comparative analysis that considers the set of similar items may be required.

If the item is significant for a particular community or cultural group, identify the group and the reasons for its associations with the item.

The statement should preferably be written in a prose style, clearly relating the attributes of the item to the criteria.

For a large site subject to a development proposal or partial demolition it may be appropriate to present a summary statement supported by a series of subsidiary statements that respond to each of the relevant criteria. For a large complex site or area it may also be appropriate to provide subsidiary statements for individual components of the item as well as the summary statement. In some cases it may be useful to indicate the relative significance of the individual components of the item (see Gradings of Significance).

Step 7 >

Get feedback

Check that your statement of significance agrees with other views of the item.

Seek comments from the people and institutions that have provided information for your assessment.

Check the views of the owner or manager of the item on the statement of significance.

Step 8 >

Write up all your information

If you are preparing a nomination for listing complete a nomination form or inventory sheet for the item (this can be downloaded from www.heritage.nsw.gov.au).

Retain all analysis as an archival record.

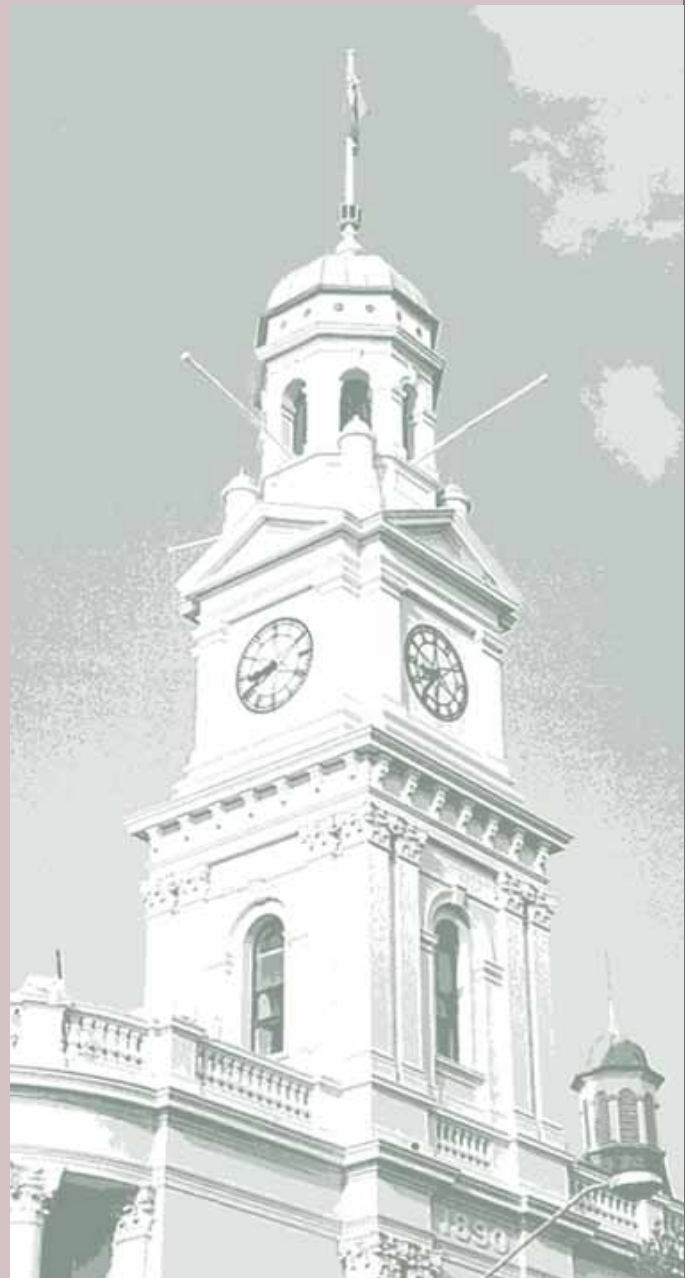

3.

Heritage significance criteria

The NSW heritage assessment criteria encompass the four values in the Australia ICOMOS *Burra Charter*, which are commonly accepted as generic values by Australian heritage agencies and professional consultants:

- **historical significance**
- **aesthetic significance**
- **scientific significance**
- **social significance**

The values are expressed as criteria in a more detailed form than this to:

- maintain consistency with the criteria of other Australian heritage agencies;
- minimise ambiguity during the assessment process; and
- avoid the legal misinterpretation of the completed assessments of listed items.

They are based on the criteria used by the Australian Heritage Commission for the assessment of potential items for the Register of the National Estate and are in line with the standard criteria adopted by other state heritage agencies.

In past years assessments of geographical regions in New South Wales – such as the Illawarra and the North Coast – have been undertaken. These surveys added a third level – regional significance – between local and State. To simplify the assessment process the Heritage Council has since discontinued the use of regional significance and now uses only local and State significance as the two levels of significance within New South Wales. Items previously identified as of regional significance will need to be re-assessed against these two levels.



4.

NSW heritage assessment criteria

An item will be considered to be of State (or local) heritage significance if, in the opinion of the Heritage Council of NSW, it meets one or more of the following criteria:

Criterion (a)

An item is important in the course, or pattern, of NSW's cultural or natural history (or the cultural or natural history of the local area);

Criterion (b)

An item has strong or special association with the life or works of a person, or group of persons, of importance in NSW's cultural or natural history (or the cultural or natural history of the local area);

Criterion (c)

An item is important in demonstrating aesthetic characteristics and/or a high degree of creative or technical achievement in NSW (or the local area);

Criterion (d)

An item has strong or special association with a particular community or cultural group in NSW (or the local area) for social, cultural or spiritual reasons;

Criterion (e)

An item has potential to yield information that will contribute to an understanding of NSW's cultural or natural history (or the cultural or natural history of the local area);

Criterion (f)

An item possesses uncommon, rare or endangered aspects of NSW's cultural or natural history (or the cultural or natural history of the local area);

Criterion (g)

An item is important in demonstrating the principal characteristics of a class of NSW's

- cultural or natural places; or
- cultural or natural environments.

(or a class of the local area's

- cultural or natural places; or
- cultural or natural environments.)

An item is not to be excluded from the Register on the ground that items with similar characteristics have already been listed on the Register.

While all criteria should be referred to during the assessment, only particularly complex items or places will be significant under all criteria. In many cases, items of environmental heritage will be significant under only one or two criteria.

In using these criteria it is important to assess the values first, then the context in which they are significant. Decide the appropriate context by considering similar items of local and State significance in each of these contexts.

These criteria were gazetted following amendments to the Heritage Act which came into force in April 1999. The Heritage Council determines the criteria for State significance and issues guidelines to assist in their application.

5.

How to assess heritage significance

The following criteria and guidelines indicate the kinds of questions that should be asked in making a heritage assessment. The guidelines are not a substitute for independent critical analysis and sound judgment. The particular qualities of the individual item should guide the assessment process.

The inclusion and exclusion guidelines are a checklist only – they do not cancel each other out. The exclusion guidelines should not be applied in isolation from the inclusion guidelines, but should be used to help in reviewing and qualifying the conclusions reached.

An item is **significant** in terms of the particular criterion if the kind of attributes listed in the *inclusion* guidelines help to describe it. Similarly, the item is **not significant** in terms of the particular criterion if the kind of attributes listed in the *exclusion* guidelines help to describe it.

Items of both local and State heritage significance have been used in the following pages to illustrate the NSW heritage assessment criteria. Accordingly, all criteria are expressed in optional terms as State or local. In most cases the level of significance will be the last question that needs to be addressed in the assessment process.

The examples used in the following pages demonstrate significance based on each individual criterion. The examples on page 26 and 27 have also been included to demonstrate how the criteria can be used to assess sites whose significance is related to more than one criterion.



6.

Gradings of significance

Different components of a place may make a different relative contribution to its heritage value. Loss of integrity or condition may diminish significance. In some cases it may be useful to specify the relative contribution of an item or its components. While it is useful to refer to the following table when assessing this aspect of significance it may need to be modified to suit its application to each specific item.

Grading	Justification	Status
EXCEPTIONAL	Rare or outstanding element directly contributing to an item's local and State significance.	Fulfils criteria for local or State listing.
HIGH	High degree of original fabric. Demonstrates a key element of the item's significance. Alterations do not detract from significance.	Fulfils criteria for local or State listing.
MODERATE	Altered or modified elements. Elements with little heritage value, but which contribute to the overall significance of the item.	Fulfils criteria for local or State listing.
LITTLE	Alterations detract from significance. Difficult to interpret.	Does not fulfil criteria for local or State listing.
INTRUSIVE	Damaging to the item's heritage significance.	Does not fulfil criteria for local or State listing.

7.

Using the heritage significance criteria

7.1 Criterion (a)

An item is important in the course, or pattern, of NSW's cultural or natural history (State significance); **OR**

An item is important in the course, or pattern, of the local area's cultural or natural history (local significance).

Guidelines for INCLUSION

- shows evidence of a significant human activity
- is associated with a significant activity or historical phase
- maintains or shows the continuity of a historical process or activity

Guidelines for EXCLUSION

- has incidental or unsubstantiated connections with historically important activities or processes
- provides evidence of activities or processes that are of dubious historical importance
- has been so altered that it can no longer provide evidence of a particular association

Types of items which meet criterion (a) include:

- items which demonstrate strong associations to past customs, cultural practices, philosophies or systems of government, regardless of the intactness of the item or any structure on the place;
- items associated with significant historical events, regardless of the intactness of the item or any structure on the place;
- significant cultural landscapes and other items demonstrating overlays of the continual pattern of human use and occupation; and/or
- items where the physical fabric (above or below ground) demonstrates any of the points described above.

The inclusion guidelines are pointers to assist in making an assessment against this criterion, but should not constrict the consideration. Similarly, the attributes described in the exclusion guidelines can be used to check if the fabric of the item or place meets the criterion, or to check a judgment that an item does not meet this criterion.

The level of heritage significance at State or local levels can only be determined by comparison with other like items. The attributes described for criteria (f) and (g) can assist in the determination of significance. A heritage item is not to be excluded on the ground that items with similar characteristics have already been entered on a statutory list.

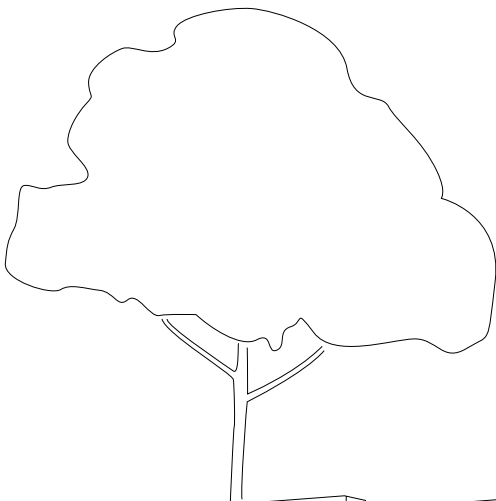



Photograph: Penny Crook, Godden Mackay Logan

Example 1: Vinegar Hill

The Battle of Vinegar Hill ended an Irish convict rebellion in 1804, when more than 300 convicts escaped the barracks at Castle Hill north west of Sydney, hoping to make their way to Sydney Harbour, and from there to freedom. The rebels did not get far. They were intercepted by Major George Johnston at Rouse Hill and rushed into battle crying 'Liberty or Death'. Fifteen were killed fighting, eight were hanged and all others punished.

While no physical fabric of this conflict survives, the site where the battle occurred is now a grassy rise overlooking Windsor Road at Rouse Hill, marked by a memorial. It is significant as a reminder of this important event, and for its association with an early manifestation of Australia's spirit of liberty, freedom and equality.

(Source: *The Battle of Vinegar Hill...a quest for Liberty*, by Blacktown City Council, 1990.)

Significance: State

Local government area: Blacktown City

Statutory Listings: Blacktown City Local Environmental Plan (Gazette No. 43, p 02156, 7 May 1993; Ref. No. 1988)

Inclusion guidelines satisfied:

- is associated with a significant activity or historical phases



Photograph: Stuart Humphreys

Example 2: Day of Mourning Protest Site

The Australian Hall at 150-52 Elizabeth Street was the site of the first organised Aboriginal civil liberties protest in Australia on Australia Day 1938. About one hundred Aboriginal men, women and elders from Sydney, regional NSW and even Melbourne, gathered in the Australian Hall on what was for them a Day of Mourning. They met to debate a ten-point list of demands aimed at redressing the political and legal disadvantages of the Aboriginal people.

This list was presented to the Prime Minister Joseph Lyons four days later and formally began the struggle for indigenous rights. A theatre, art-house cinema and clubhouses operated from the building until 1999 when it was purchased by the Indigenous Land Trust to house a museum of Aboriginal heroes.

The site is an important place in the Aboriginal and political history of Australia and is significant for its association with the beginning of the continuing struggle for the rights of Aboriginal people.

(Source: Assessment of an Aboriginal place Application for the 'Day of Mourning Protest' site, Cyprus Hellene Club, 150-152 Elizabeth Street, Sydney, by Phil Hunt, National Parks and Wildlife Service, January 1997.)

Significance: State

Local government area: Sydney City

Statutory Listings: State Heritage Register (Gazette No. 27, p 1546, 2 April 1999; Ref. No. 00773); Register of the National Estate (Registered 28 May 1996, Database No. 019576); Sydney City Local Environmental Plan (Gazette No. 42, p 2459; Ref. No. 4127)

Non-Statutory Listings: National Trust Register

Inclusion guidelines satisfied:

- is associated with a significant activity or historical phases

7. Using the heritage significance criteria (cont.)

7.2 Criterion (b):

An item has strong or special association with the life or works of a person, or group of persons, of importance in NSW's cultural or natural history (State significance); OR

An item has strong or special association with the life or works of a person, or group of persons, of importance in the cultural or natural history of the local area (local significance).

Guidelines for INCLUSION

- shows evidence of a significant human occupation
- is associated with a significant event, person, or group of persons

Guidelines for EXCLUSION

- has incidental or unsubstantiated connections with historically important people or events
- provides evidence of people or events that are of dubious historical importance
- has been so altered that it can no longer provide evidence of a particular association

Types of items which meet this criterion include:

- items which demonstrate strong associations to a particular event, historical theme, people or philosophies, regardless of the intactness of the item or any of its structures;
- items associated with significant historical events, regardless of the intactness of the item or any structure on the place; and/or
- items where the physical fabric (above or below ground) demonstrates any of the points described above.

The inclusion guidelines are pointers to assist in making an assessment against this criterion, but should not constrict the consideration. Similarly, the attributes described in the exclusion guidelines can be used to check if the fabric of the item or place meets the criterion, or to check a judgment that an item does not meet this criterion.

For example, a place may be considered significant because an important historical figure was said to have lived there. However, further research may reveal insufficient evidence of that fact, or that the period of habitation was too brief to be relevant to the life and work of the historical figure.

The level of heritage significance at State or local levels can only be determined by comparison with other like items. The attributes described for criteria (f) and (g) can assist in the determination of significance. A heritage item is not to be excluded on the ground that items with similar characteristics have already been entered on a statutory list.

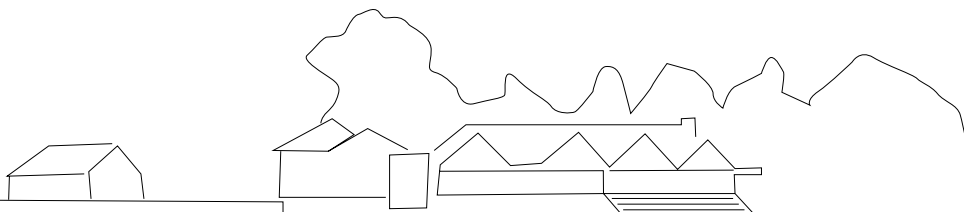



Photograph: Karl Zhao

Example 1: Chinese Market Gardens

The site of the La Perouse Chinese Market Gardens has been associated with modification of the land during Aboriginal occupation, followed by vegetable cultivation and use of the land during European occupation. The first European farms in the area were recorded in 1830. From the end of the 1850s gold rush the site has become almost exclusively associated with Chinese market gardeners. One of the oldest of its kind in Australia, the site has been managed by members of the Chinese community for over 90 years.

The La Perouse Chinese Market Gardens have strong associative links with the Chinese community in Sydney. It is a surviving example of working market gardens still using mostly manual labour, that were originally widespread throughout the La Perouse area.

(Source: State Heritage Inventory 5044696.)

Significance: State

Local government area: Randwick City

Statutory Listings: State Heritage Register (Gazette No. 92, p 5797, 13 August 1999; Ref. No. 01299); Randwick Local Environment Plan 2000 (Gazette No. 93, p 6550, 21 July 2000)

Non-statutory Listings: none

Inclusion guidelines satisfied:

- shows evidence of a significant human occupation
- is associated with a significant event, person, or groups of persons



Photograph: Courtesy of the Bradman Museum, Bowral

Example 2: Bradman Oval & Museum

Cricket has been played on the Bradman Oval, at Bowral, since 1893. Sir Donald Bradman himself played there from the age of twelve. Formerly 'The Glebe', the grounds were renamed Bradman Oval in 1947. The collection of cricket memorabilia held and displayed in the Bradman Museum (opened in 1996 by the Bradman Foundation) includes clothing, sports equipment, medals, pennants, certificates, trophies, badges, photos and ephemera. These items provide evidence of Sir Donald's career and the history of Australian cricket.

Bradman Oval and its related museum collection of sports memorabilia have a special and strong association with the cricketing career of the late Sir Donald Bradman – an Australian sporting hero and national icon.

(Source: State Heritage Inventory 5014211.)

Significance: State

Local government area: Wingecarribee

Statutory Listings: State Heritage Register (Gazette No. 73, p 5230, 23 June 2000, Ref. No. 01399)

Non-statutory Listings: none

Inclusion guidelines satisfied:

- is associated with a significant event, person or groups of persons



7. Using the heritage significance criteria (cont.)

7.3 Criterion (c):

An item is important in demonstrating aesthetic characteristics and/or a high degree of creative or technical achievement in NSW (State significance);
OR

An item is important in demonstrating aesthetic characteristics and/or a high degree of creative or technical achievement in the local area (local significance).

Guidelines for INCLUSION

- shows or is associated with, creative or technical innovation or achievement
- is the inspiration for a creative or technical innovation or achievement
- is aesthetically distinctive
- has landmark qualities
- exemplifies a particular taste, style or technology

Guidelines for EXCLUSION

- is not a major work by an important designer or artist
- has lost its design or technical integrity
- its positive visual or sensory appeal or landmark and scenic qualities have been more than temporarily degraded
- has only a loose association with a creative or technical achievement

Types of items which meet this criterion include:

- items which demonstrate creative or technical excellence, innovation or achievement;
- items which have been the inspiration for creative or technical achievement;
- items which demonstrate distinctive aesthetic attributes in form or composition;
- items which demonstrate a highly original and influential style, such as an important early (seminal) work of a major architect; and/or
- items which demonstrate the culmination of a particular architectural style (known as climactic).

The inclusion guidelines are pointers to assist in making an assessment against this criterion, but should not constrict the consideration. Similarly, the attributes described in the exclusion guidelines can be used to check if the fabric of the item or place meets the criterion, or to check a judgment that an item does not meet this criterion.

An item may be considered significant under this criterion if it is a major landmark in a town, or it is the first major work in a particular architectural style. It will not be significant if its landmark qualities have been diminished by surrounding development, or it is only one of many examples of the architectural style.

The level of heritage significance at State or local levels can only be determined by comparison with other like items. The attributes described for criteria (f) and (g) can assist in the determination of significance. A heritage item is not to be excluded on the ground that items with similar characteristics have already been entered on a statutory list.

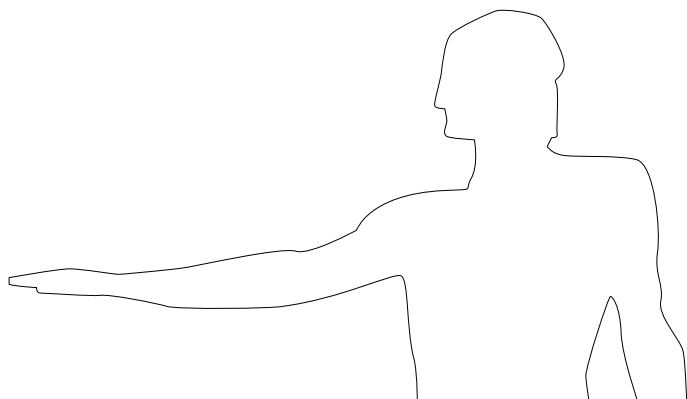



Photograph: Cameron White

Example 1: Brewarrina Fish Traps

Known as Ngunnhu to the local Aboriginal community, the Brewarrina fish traps consist of several kidney-shaped and diamond-shaped enclosures with interconnecting walls, about 50 cm high, which stretch for about half a kilometre across a major rock bar of the Barwon River. Boulders were placed in front of the traps, and when fish swimming against the rapids rested behind these large stones they were captured with wood and reed nets.

The fish traps exemplify the skill and technical expertise of food-gathering strategies of Aboriginal people in western NSW. The traps are a clear manifestation of traditional Aboriginal engineering skill, and their knowledge of the river's hydrology and marine life.

(Source: State Heritage Register Report 2000, NPWS Site Report 1977.)

Significance: State

Local government area: Brewarrina

Statutory Listings: State Heritage Register (Gazette No. 103, p 7669, 11 August 2000; Ref. No. 01413); Register of the National Estate (Registered 21 October 1980, Database No. 000520); National Parks and Wildlife Register (Listed 3 February 1977); Brewarrina Local Environmental Plan (Heritage Item No. 5, Gazetted 2000)

Non-statutory Listings: National Trust (Industrial Archaeological Sites List)

Inclusion guidelines satisfied:

- shows or is associated with, creative or technical innovation or achievement
- is aesthetically distinctive
- exemplifies a particular taste, style or technology



Photograph: Penny Crook, Godden Mackay Logan

Example 2: Archibald Fountain

The Archibald Fountain in Sydney's Hyde Park was built in 1932 as the bequest of Jules Francois Archibald, founder of the *Bulletin* magazine, to commemorate the war-time alliance of France and Australia. Designed by French sculptor Francois Sicard, the life-size classical bronze figures are cast in an angular form typical of early Art Deco style. The Greek sun-god Apollo with a water-spray of the sun's rays at his feet presides over other deities, representing the ascendancy of nature over agriculture, civilisation and personal sacrifice.

The Archibald Fountain is an outstanding example of international, Art Deco public sculpture and is a dominant landmark element whose alignment with the War Memorial to the south forms the primary visual axis of Hyde Park.

(Source: State Heritage Inventory 15964; Register of the National Estate ID 015874; *A Spirit of Progress* by Patrick Van Daele and Roy Lumby, 1997.)

Significance: State

Local government area: Sydney City

Statutory Listings: Local Environmental Plan (Gazette No. 42, p 2483, 3 April 1992; Ref. 8023); Register of the National Estate (Gazette No. 11, p 47, Registered 14 May 1991, Database No. 015874)

Non-statutory Listings: National Trust Register

Inclusion guidelines satisfied:

- shows or is associated with, creative or technical innovation or achievement
- is aesthetically distinctive
- has landmark qualities
- exemplifies a particular taste, style or technology

7. Using the heritage significance criteria (cont.)

7.4 Criterion (d):

An item has strong or special association with a particular community or cultural group in NSW for social, cultural or spiritual reasons (State significance); **OR**

An item has strong or special association with a particular community or cultural group in the area for social, cultural or spiritual reasons (local significance).

Guidelines for INCLUSION

- is important for its associations with an identifiable group
- is important to a community's sense of place

Guidelines for EXCLUSION

- is only important to the community for amenity reasons
- is retained only in preference to a proposed alternative

Types of items which meet this criterion include:

- items which are esteemed by the community for their cultural values;
- items which if damaged or destroyed would cause the community a sense of loss; and/or
- items which contribute to a community's sense of identity.

Items are excluded if:

- they are valued only for their amenity (service convenience); and/or
- the community seeks their retention only in preference to a proposed alternative.

The inclusion guidelines are pointers to assist in making an assessment against this criterion, but should not constrict the consideration. Similarly, the attributes described in the exclusion guidelines can be used to check if the fabric of the item or place meets the criterion, or to check a judgment that an item does not meet this criterion.

Note the use of the adjective 'particular' in this criterion. An item does not need to be known to or valued by the whole community in a town or geographical area to be significant. The 'particular' community may be defined by such things as a common ethnic background or religious belief or profession.

Care must be taken not to confuse heritage significance with amenity or utility. For example, a community may seek the retention of an older building in preference to its replacement with a more intensive development of a site. In such cases, there must be evidence that the item is separately valued in accordance with this criterion or one of the other criteria to have any validity as a significant heritage item.

The level of heritage significance at State or local levels can only be determined by comparison with other like items. The attributes described for criteria (f) and (g) can assist in the determination of significance. A heritage item is not to be excluded on the ground that items with similar characteristics have already been entered on a statutory list.



Photograph: Mary Dallas



Photograph: Courtesy of the Old Bar Lions Club Inc

Example 1: Hill 60

Shell middens and campsites at Hill 60, Port Kembla bear testimony to the long history of Aboriginal association with the area. In the late-nineteenth century, a highly successful Aboriginal fishing enterprise supplying the local and Sydney markets was developed at the Hill and operated until the 1940s. Aboriginal families lived on Hill 60 in houses they built and maintained themselves, until their forced removal in 1942.

While nothing remains of these homes today, many of the Aboriginal people raised on Hill 60 vividly recall the coastal life of their childhood, and have retained very strong social and cultural links to the Hill. For the Wadi Wadi and broader Aboriginal community of the New South Wales south coast, Hill 60 has strong social, cultural and spiritual associations with both traditional and modern Aboriginal ways of life.

(Source: State Heritage Inventory 5051311.)

Significance: State

Local government area: Wollongong City

Statutory Listings: none

Non-statutory Listings: none

Inclusion guidelines satisfied:

- is important for its associations with an identifiable group
- is crucial to a community's sense of place

Example 2: Old Bar Airfield

The Airfield at Old Bar, built around 1930, was one of the earliest aerodromes and the main refuelling stop for pilots flying from Sydney to Brisbane. These included aviation pioneers such as Sir Charles Kingsford-Smith, Captain C.T.P. Ulm, Jean Batten and Nancy 'Bird' Walton. The special association of the airfield to aviators and locals was brought to light when the airfield was threatened by closure in 1989 and 1995. The airfield is now used on an occasional basis.

The community of Old Bar on NSW's mid-north coast and aviators throughout Australia have a special association with the Old Bar Airfield. Together, they have successfully campaigned for the recognition of the airfield's importance to Australia's early aviation history. This outward expression of community esteem demonstrates strong social value in addition to the Airfield's historic significance.

(Source: State Heritage Inventory 5014216.)

Significance: State

Local government area: Greater Taree City

Statutory Listings: State Heritage Register (Gazette No. 29, p 1532, 25 February 2000; Ref. No. 01304); Register of the National Estate – Interim List (Interim listed 21 November 2000; Database No. 018854)

Non-statutory Listings: National Trust Register (Classified 27 July 1998)

Inclusion guidelines satisfied:

- Is important for its associations with an identifiable group (aviation pioneers and aviation community today)
- Is crucial to a community's sense of place

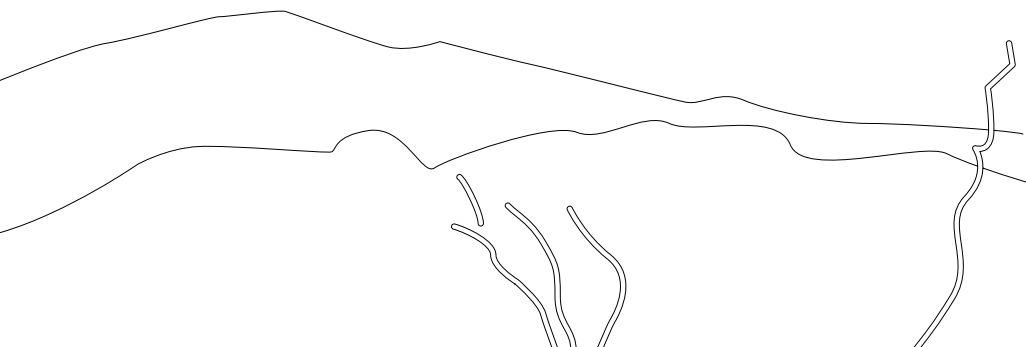

7. Using the heritage significance criteria (cont.)

7.5 Criterion (e):

**An item has potential to yield information that will contribute to an understanding of NSW's cultural or natural history (State significance); OR
An item has potential to yield information that will contribute to an understanding of the area's cultural or natural history (local significance).**

Guidelines for INCLUSION

- has the potential to yield new or further substantial scientific and/or archaeological information
- is an important benchmark or reference site or type
- provides evidence of past human cultures that is unavailable elsewhere

Guidelines for EXCLUSION

- the knowledge gained would be irrelevant to research on science, human history or culture
- has little archaeological or research potential
- only contains information that is readily available from other resources or archaeological sites

The inclusion guidelines are pointers to assist in making an assessment against this criterion, but should not constrict the consideration. Similarly, the attributes described in the exclusion guidelines can be used to check if the fabric of the item or place meets the criterion, or to check a judgment that an item does not meet this criterion.

In addition to a detailed examination of surviving physical fabric, documents, oral history and other sources of evidence can often assist the assessment of whether a site has the ability to reveal valuable archaeological, technical, or scientific information. For example, it may become apparent that the buried footings of a colonial house have little integrity if there is historical evidence that the site has been so disturbed that there will be no additional archaeological deposits associated with the use of the house.

The level of heritage significance at State or local levels can only be determined by comparison with other like items. The attributes described for criteria (f) and (g) can assist in the determination of significance. A heritage item is not to be excluded on the ground that items with similar characteristics have already been entered on a statutory list.

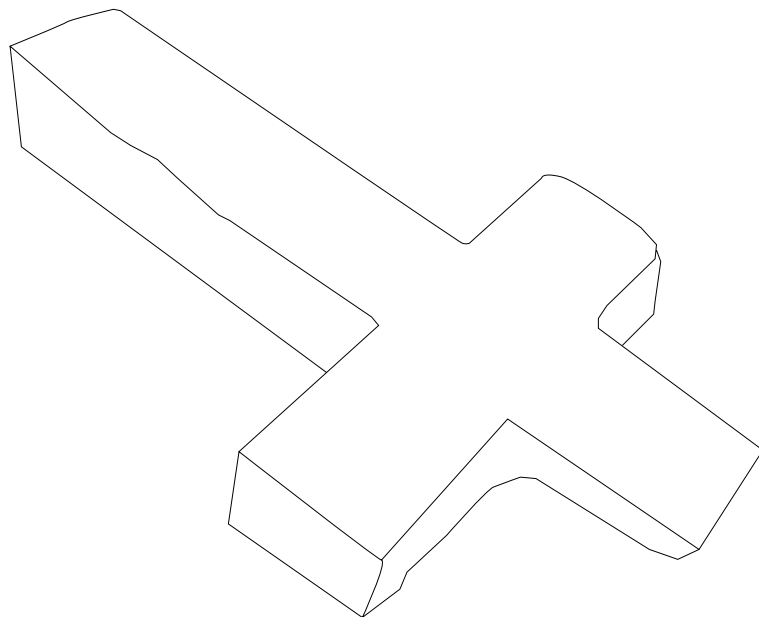



Photograph: David Nutley

Example 1: Queen of Nations

The wreck of the clipper ship *Queen of Nations* contains a unique assemblage of imported cargo which went down with the ship in May 1881, ranging from bottled vegetables to cemetery headstones. The wooden ship itself is a valuable source of information about British ship building at the time. With the historical records which chronicled the break-up of the vessel, the wreck could provide an excellent benchmark study of the processes of shipwreck collapse and deterioration.

The *Queen of Nations* site, sealed underwater north of Wollongong, forms one of the most intact archaeological deposits relating to late-nineteenth century trade in New South Wales. The physical evidence at the site has outstanding scientific research value.

(Source: Queen of Nations [1861–1881] Management Plan by the Heritage Branch, Department of Planning, 1992.)

Significance: State

Local government area: Wollongong City

Statutory Listings: National Shipwreck Register (ID 1514)

Non-statutory Listings: none

Inclusion guidelines satisfied:

- has the potential to yield new or further substantial scientific and/or archaeological information
- is an important benchmark or reference site or type
- provides evidence of past human cultures that is unavailable elsewhere



Photograph: Patrick Grant, Godden Mackay Logan

Example 2: The Rocks Dig Site

Fine Chinese porcelain bowls decorated with silver floral sprays and red lines were found in the well of the ex-convict butcher George Cribb at the Cumberland and Gloucester Streets Site in Sydney's Rocks district in 1994. Along with historical evidence, archaeological features and deposits have provided a new perspective on the often bleak history of convicts in the Rocks.

This is just one of many avenues of research which has advanced following the excavation of the site. Many building foundations and unexcavated deposits have been preserved on site which, along with a collection of 750,000 boxed and catalogued artefacts, provide a vast and long-term research resource.

The scientific significance of the Cumberland and Gloucester Streets site is embodied in the ability of the physical evidence – both the place itself and the artefacts it contains – to provide new information and insight into Sydney's convict past and nineteenth century social life.

(Source: *The Cumberland/Gloucester Streets Site Archaeological Investigation Reports* by Godden Mackay Logan, 1999.)

Significance: State

Local government area: Sydney City

Statutory Listings: Sydney Harbour Foreshore Authority Section 170 Register (Listed 1 March 1998, Database No. 4500363)

Non-statutory Listings: National Trust Register

Inclusion guidelines satisfied:

- has the potential to yield new or further substantial scientific and/or archaeological information
- is an important benchmark or reference site or type
- provides evidence of past human cultures that is unavailable elsewhere

7. Using the heritage significance criteria (cont.)

7.6 Criterion (f):

An item possesses uncommon, rare or endangered aspects of NSW's cultural or natural history

(State significance); **OR**

An item possesses uncommon, rare or endangered aspects of the area's cultural or natural history

(local significance).

Guidelines for INCLUSION

- provides evidence of a defunct custom, way of life or process
- demonstrates a process, custom or other human activity that is in danger of being lost
- shows unusually accurate evidence of a significant human activity
- is the only example of its type
- demonstrates designs or techniques of exceptional interest
- shows rare evidence of a significant human activity important to a community

Guidelines for EXCLUSION

- is not rare
- is numerous but under threat

The inclusion guidelines are pointers to assist in making an assessment against this criterion, but should not constrict the consideration. Similarly, the attributes described in the exclusion guidelines can be used to check if the fabric of the item or place meets the criterion, or to check a judgment that an item does not meet this criterion.

For example, a park in a country town may be said to be a *rare* example of Victorian public garden design, but further research may reveal that it is a *representative* example, as there are many such parks in country towns in NSW. If it is one of the few remaining examples of an important 19th century garden designer, or contains species not found in similar gardens elsewhere, it may qualify as rare in the NSW context. Assuming it is the only garden of its type in the local area, it is likely it would also be rare in the local context.

The level of heritage significance at State or local levels can only be determined by comparison with other like items or by proving that there is no documentation on similar items. This helps in determining the heritage significance of an item.

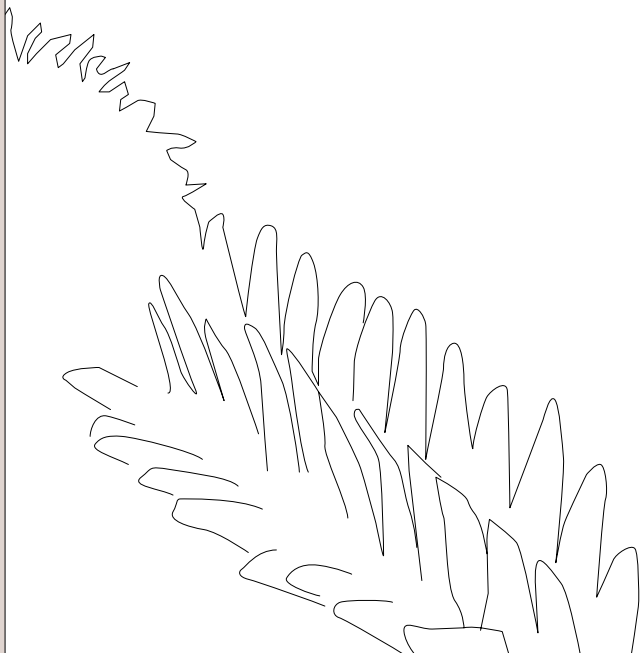



Photograph: Jaime Plaza, Royal Botanic Gardens Sydney

Example 1: Wollemi Pine

The Wollemi Pine (*Wollemia nobilis*) is the newly discovered living genus of the conifer family *Araucariaceae*. It is a 'living fossil', having many features in common with Cretaceous and early Tertiary fossil groups. The first of two small, isolated tree populations was discovered in 1994 in a sheltered gorge in Wollemi National Park north-west of Sydney. Only 38 adult trees are found in these two stands. Some may be between 500 and 1000 years old. The Pine is preserved in an undisclosed location, and cultivated trees have been planted in the Royal Botanic Gardens and Taronga Park Zoo, in Sydney.

The Wollemi Pine is one of the rarest plant species in the world.

(Sources: Royal Botanic Gardens Website, *The Wollemi Pine* by James Woodford, 2000.)

Significance: State

Statutory Listings: Register of the National Estate, as part of Wollemi National Park (Registered 21 October 1980, Database No. 000833)

Non-statutory Listings: none

Inclusion guidelines satisfied:

- is the only example of its type



Photograph: Parliament of New South Wales

Example 2: Sydney Harbour Bridge Scissors

The scissors that cut the ribbon to open the Sydney Harbour Bridge were made by Sydney jewellers Angus & Coote and donated to the NSW Government in 1932 by the builders of the bridge, the British engineering firm Dorman and Long. Set with 6 opals, the handles are embellished with native flowers and below this, two arches meet to form a miniature Sydney Harbour Bridge. Today the scissors are on public display in the NSW Parliament and are still used in official opening ceremonies.

As a special artefact with a unique design that reflects their role in a key event in Australian history, the Sydney Harbour Bridge scissors are a rare item of outstanding heritage significance.

(Source: NSW Parliament House display.)

Significance: State

Statutory Listings: none

Non-statutory Listings: none

Inclusion guidelines satisfied:

- is the only example of its type
- demonstrates designs or techniques of exceptional interest
- shows rare evidence of a significant human activity important to a community

7. Using the heritage significance criteria (cont.)

7.7 Criterion (g):

An item is important in demonstrating the principal characteristics of a class of NSW's

- cultural or natural places; or
- cultural or natural environments
(State significance); **OR**

An item is important in demonstrating the principal characteristics of a class of the area's

- cultural or natural places; or
- cultural or natural environments
(local significance).

Guidelines for INCLUSION

- is a fine example of its type
- has the principal characteristics of an important class or group of items
- has attributes typical of a particular way of life, philosophy, custom, significant process, design, technique or activity
- is a significant variation to a class of items
- is part of a group which collectively illustrates a representative type
- is outstanding because of its setting, condition or size
- is outstanding because of its integrity or the esteem in which it is held

Guidelines for EXCLUSION

- is a poor example of its type
- does not include or has lost the range of characteristics of a type
- does not represent well the characteristics that make up a significant variation of a type

The inclusion guidelines are pointers to assist in making an assessment against this criterion, but should not restrict the consideration. A fine representative example needs to demonstrate key characteristics of its type or class. The intactness of the physical fabric of an item (its integrity) is another attribute that can be used to qualify the rare or representative criteria – see Section 6 of these guidelines. The attributes described in the exclusion guidelines can be used to check if the item or place meets the criterion or to check a judgment that an item does not meet this criterion.

For example, a group of Victorian cottages in a place with many examples of 19th century architecture, such as Bathurst or the inner suburbs of Sydney, may have representative value. In another city or suburb in which most of the 19th century architecture has been replaced they may be assessed as rare.

The level of heritage significance at State or local levels can only be determined by comparison with other like items. The attributes described for criteria (f) and (g) will assist in the determination of significance. A heritage item is not to be excluded on the ground that items with similar characteristics have already been entered on a statutory list.

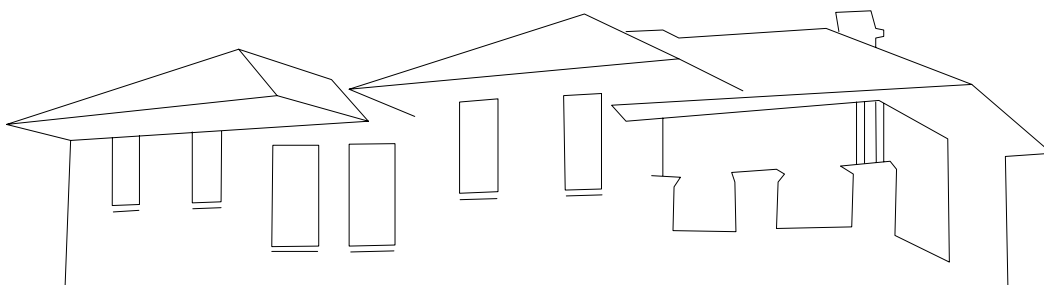



Photograph: Jennifer Armstrong, Godden Mackay Logan

Example 1: Glen Innes Post Office

Built to a design of the Government Architect's Office in 1896, Glen Innes Post Office is a typical Federation period public building. The intact upper-floor residence is typical of post office design and construction during this period, when the postmaster was provided with living quarters in the same building. The finely detailed archways, face brick and sandstone of the building are examples of the Federation Arts and Crafts style civic buildings designed by the Government Architect, Walter Liberty Vernon. The building continues to function as a post office.

The Post Office building is of representative significance because it demonstrates the principal characteristics of post offices designed and constructed in the late-nineteenth century by the NSW Government Architect's Office.

(Source: State Heritage Inventory 5044753, prepared by Godden Mackay Logan, January 2000.)

Significance: State

Local government areas: Glen Innes

Statutory Listings: State Heritage Register (Gazette No. 73, p 5231, 23 June 2000, Ref. No. 01406); Register of the National Estate (Registered 21 March 1978, Database No. 000321)

Non-Statutory Listings: National Trust Register

Inclusion guidelines satisfied:

- Is a fine example of its type
- Has the potential characteristics of an important class or group of items
- Has attributes typical of a particular way of life, philosophy, custom, significant process, design, technique or activity
- Is part of a group which collectively illustrates a representative type



Photograph: Lianne Hall

Example 2: Paddington

Paddington is a fine example of a late-Victorian suburb that has largely survived in excellent condition. The area's range of terraces, modest workers' cottages, townhouses and former mansions are set within a network of streets, lanes and pedestrian links typical of Victorian urban development and subdivision. Its built fabric and historical documentation of domestic life provide an excellent example of the processes and products of inner-city land speculation during the 'boom' period from 1870 to 1895. It was one of the first conservation areas in New South Wales to gain official recognition.

Paddington has representative significance as an intact late Victorian suburb that, through its physical form, building stock and history, demonstrates and typifies inner city development and life in the late nineteenth century.

(Sources: *Paddington Development Control Plan* Woollahra Municipal Council 1999, Register of the National Estate Database.)

Significance: State

Local government areas: Woollahra

Statutory Listings: Woollahra Municipal Council Paddington DCP 1999; Register of the National Estate (Paddington Conservation Area Registered 21 October 1980)

Non-statutory Listings: National Trust Register

Inclusion guidelines satisfied:

- is a fine example of its type
- has attributes typical of a particular way of life, philosophy, custom, significant process, design, technique or activity
- is outstanding because of its setting, condition or size

7. Using the heritage significance criteria (cont.)

7.8 Examples of items demonstrating multiple criteria

Example 1: Willandra Lakes

The spectacular dried-up Willandra Lakes system in western NSW has diverse heritage significance. With its rich history and remarkable physical cultural heritage, it is an example of a place that demonstrates multiple assessment criteria.

The 240,000 hectare system is of exceptional importance to the continent's landscape history and the development and innovation of Aboriginal culture. It is one of the oldest known places of continuous human occupation in Australia, beginning with the exploitation of the lakes' rich freshwater resources by Aboriginal people around 40,000 years ago and continuing into the modern period of pastoral settlement. The lakes are the site of the oldest ritual cremation in the world. They also contain evidence of the remarkable adaptation of Aboriginal culture and technology after the lakes dried up 15,000 years ago. **(Criterion a)**

In more recent history, the Willandra Lakes region played an important role in European exploration in the 1830s and 1840s and the ensuing pastoral expansion along the Murray and Darling Rivers. With the help of Chinese workers, expansion continued until the late 1890s, and some pastoral stations continue to operate in the region today. **(Criterion a)**



Photograph: Geoff Ashley, Godden Mackay Logan

The distinctive geomorphology of the Willandra Lakes area has substantial scientific value for its representation of well over 100,000 years of geological and biological change on the Australian continent. Much of the history of the area is known to Europeans through archaeological excavation and investigation. The site and its collection still hold the potential for further information about Aboriginal culture, more recent European working life and the history of natural processes through archaeological, historical and scientific investigation.

(Criterion e)

The area's long and diverse history, its vast resource and exceptional preservation and its special association with the Aboriginal people of the area and local landholders, make it a rare place. **(Criterion f)** It also demonstrates a broad range of characteristics of NSW's natural history, Aboriginal culture and European pastoralism. **(Criterion g)**

(Source: *Sustaining the Willandra*, The Willandra Lakes Region World Heritage Property, Plan of Management Summary by World Heritage Australia; Josephine Flood, *Archaeology of the Dreamtime*, 1995)

Significance: World

Local government area: Balranald

Statutory Listings: State Heritage Register (Gazette No. 27, p 1546, 2 April 1999; Ref. No. 01010); Register of the National Estate (Registered 21 March 1978, Database No. 000689); World Heritage List (inscribed 1981); Listed as a Nature Conservation Area on the Balranald Draft Local Environmental Plan

Non-Statutory Listings: National Trust Register

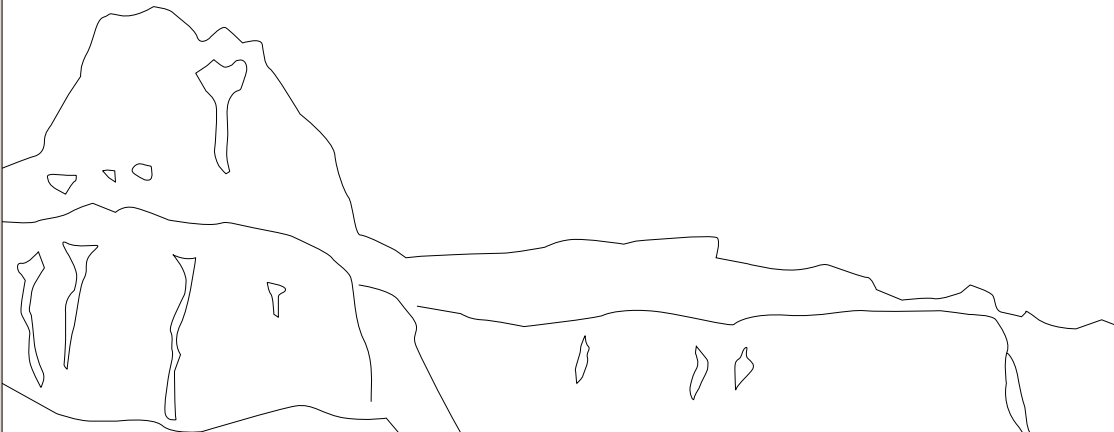



Photograph: Courtesy of Parramatta Park Trust

Example 2: Parramatta Regional Park

Parramatta Regional Park demonstrates continuous cultivation and land-use from the management of the Cumberland Plain grasslands by the Burramatta clan of the Dharug Aboriginal people and later through the processes of colonisation, from exploration to occupation, including land clearing and building. **(Criterion a)**

Following Governor Phillip's establishment of the Governor's Domain in 1790 the area contained agricultural land, stockyards, lumberyard and Governor's residence.

(Criterion a)

A landmark site, the park retains historical association with successive governors, and was the location for significant interaction between Aboriginal and European people.

(Criterion b) It demonstrates early town planning and landscaping design and features strategic and picturesque views and vistas. **(Criterion c)**

It has been used for botanical and astronomical scientific research. The park is considered both a European and Aboriginal archaeological resource of national significance.

(Criterion e)

The park has evolved from being one of the earliest successful agricultural sites of the colony, including the site of the only 18th century seat of colonial government remaining intact today, to one of the most important and earliest open spaces dedicated for public use.

The park has continuously operated as a regional park since its gazettal as a National Park in 1917. Government House was used by Governors until 1855, tenanted by the King's School and other organisations, then operated by the National Trust since 1970 as a house museum. **(Criterion a)** Parramatta Park also retains strong associations with the local Aboriginal community. **(Criterion d)**

(Source: Parramatta Park Plan of Management – Cultural Resources, Issues Paper August 1995; City of Parramatta Heritage Study Inventory Form No. 418; Register of the National Estate Database No. 003072; State Heritage Inventory 5051462.)

Significance: National

Local government area: Parramatta City

Statutory Listings: State Heritage Register (Gazette No. 27, p 1546, 2 April 1999; Ref. No. 00596); Register of the National Estate (Registered 21 October 1980, Database No. 003072); Parramatta Local Environmental Plan 1996 (Schedule 1 – Heritage Items of State or Regional Significance); Sydney Regional Environmental Plan No. 28 Parramatta (Schedule 6 – Heritage Items)

Non-Statutory Listings: National Trust Register

8.

Other information

Using a standard procedure

It is important that all heritage assessments in NSW are carried out in accordance with the procedures described in this guideline so that assessments are:

- accountable and can be tested;
- comparable;
- consistent (because the same criteria are used in every case across the State); and
- applicable to all types of heritage items.

Aboriginal heritage assessment

Aboriginal heritage sites and Aboriginal communities are part of a living culture. Aboriginal Heritage Officers in the National Parks and Wildlife Service (NPWS) have prepared guidelines that assist the assessment of the cultural value of Aboriginal heritage places within present-day Aboriginal culture. The *Aboriginal Heritage Standards and Guidelines Kit* is available from NPWS, PO Box 1967, Hurstville 2220 (Ph: (02) 9585 6444, Fax: (02) 9585 6555).

It is important to use these guidelines because the local and State levels of significance used in the assessment of other items do not easily translate to the assessment of Aboriginal heritage items.

The listing of items of Aboriginal heritage on the State Heritage Register is recommended to the Heritage Council by its Aboriginal Heritage Committee. Assessment of Aboriginal heritage items is undertaken in collaboration with the National Parks and Wildlife Service.

Archaeological heritage assessment

Archaeological significance is part of the heritage significance of many land-based heritage items. A separate guideline, *Archaeological Assessments*, explains the processes involved in the investigation of archaeological sites.

There are 1,600 known maritime archaeology sites along the coast of NSW and 200 in inland lakes and rivers. More sites are being found and researched each year. Assessments of wreck sites should be prepared by qualified maritime archaeologists.

Natural heritage assessment

The assessment of natural heritage items can include reference to any of the assessment criteria. Scientific values are particularly important in the conservation of species habitats and eco-systems. Cultural values will be more relevant in those areas where there has been a long or varied interaction between man and the natural environment.

Assessments should take account of the Heritage Council's *Natural Heritage Principles* and the National Parks & Wildlife Service's *Land for Wildlife Notes* and *Land for Wildlife Newsletter*.

Statutory heritage lists

Only lists based on legislation have statutory standing in NSW. Heritage items with statutory protection include:

- items of local heritage significance listed on schedules to local environmental plans
- items of special significance to the people of NSW listed on the State Heritage Register
- NSW items on the Register of the National Estate (the Commonwealth has limited powers to restrict the actions of its agencies which affect these items).

Most of the 20,000 statutory items in NSW are listed by local councils. One hundred of the State's local councils have listed heritage items on their local environmental plans.

Statutory lists of heritage items advise owners and the community of special places and objects which should be kept for future generations to appreciate and enjoy. Owners of items on these lists need to make an application to a consent authority, such as a local council or the Heritage Council of NSW, before they can make major changes. The consent authority has the responsibility of approving only those changes that respect the heritage significance of the item.

Most of the items on local heritage schedules are of local heritage significance. But some items listed by local councils are also of State significance. The Heritage Office is working with local councils to find out which of these items should be added to the State Heritage Register.

The State Heritage Register

The State Heritage Register was created in April 1999 as a result of amendments to the *Heritage Act 1977*. The Heritage Council seeks public comment before recommending the listing of items to the Minister for Urban Affairs and Planning. Listings are published in the Government Gazette.

The Register will eventually be a comprehensive list of heritage items of significance to the people of NSW.

The State Heritage Inventory

The State Heritage Inventory is an electronic database with information on the 20,000 items on NSW statutory lists.

In most cases the information on local heritage items in the State Heritage Inventory is minimal, consisting only of the name and address of the item and the date of the local environmental plan. To find out more detailed information you will need to refer to the heritage study for your area. This should be available from your local library or your council planning department.

Some councils have developed electronic heritage databases. The Heritage Office is working with these councils to transfer this detailed information to the State Heritage Inventory.

You can access the State Heritage Inventory on the Internet through the Heritage Office's home page at:

www.heritage.nsw.gov.au

Other heritage lists

The State Heritage Inventory already includes some cross-references to heritage items in New South Wales that are identified by organisations such as the National Trust, the Art Deco Society, the Institution of Engineers and the Royal Australian Institute of Architects.

In most cases these non-statutory lists cannot be used to control future changes to the items. Their value is to alert the community, local councils and the Heritage Council of NSW to significant items that may need to be listed on the State Heritage Register or local environmental plan.



Assessing heritage significance

a *NSW Heritage Manual* update



NSW
Heritage
Office